

# L-159 ALCA

Kit of radio controlled electro- flyer powered EDF



**Wingspan:** 780 mm  
**Length:** 910 mm  
**Flight weight:** 450 g

Model of flying fighter of Czech army, which is a follower of the famous trainer airplane L-39 Albatros.

The kit of this aircraft is mainly produced of extruded polypropylene EPP. This material ensures excellent durability and lifetime. Thanks its properties, this model enables pleasant flying and very realistic flying. The model has a very straight- foward flight characteristics, and is very pleasant for piloting. Starts from the hand are completely troublefree, also landing on low speed does not make problems.

This model can be recommended as the first model driven by blower, for entry into the world of jet models.

Thanks the power unit (blower) is hidden inside the fuselage, this model is highly resistant towards accidents and potential contact with the ground and impediments. In case of damage is possible to repair directly on the runway by CyA glue.

Model is to a great extent in good degree of completion and its completion will not require much time. Model is not designated for the beginners - that is why the assembly operation is not described in details. Design and final appearance of this model shall be modified considering selected engine and modeller's skills and habits.

## List of Kit parts:

Fuselage from EPP	5 pcs
Cabin- transparent	1 pcs
Half wing from EPP	2 pcs
Control surfaces from EPP	2 pcs
Elevator joiner	wire 1.5 mm
Plywood parts	3 pcs
Control lever	3 pcs
Rudder connecting rods	1 + 2 pcs
Plastic bolt + nut	1 + 1 pcs
Magnets	2 pcs
Wing reinforcement	1 pc
Elevator reinforcement	1 pc
Fuselage reinforcement	1 pc

## Further necessary tools for assembly:

CyA glue, CyA glue accelerator, polyurethane glue, epoxy, contact glue, sharp knife

## Recommended drive:

- 1) Motor kv 4800 ot/V, blower 60/25 (Alfamodel, 5-rotor blade), 2s lipol 1300-1600 mAh, regulator 25A
- 2) Motor kv 3600 ot/V, blower 60/15 mk.2 (Alfamodel, 3-rotor blade), 3s lipol 1300-1600 mAh, regulator 25A

## Kit assembly:

Before the actual construction study carefully the building instructions and prepare equipment for construction. Constructional instruction is only a guide to building by your own. Adjust construction of assumption equipment and especially their own building skills

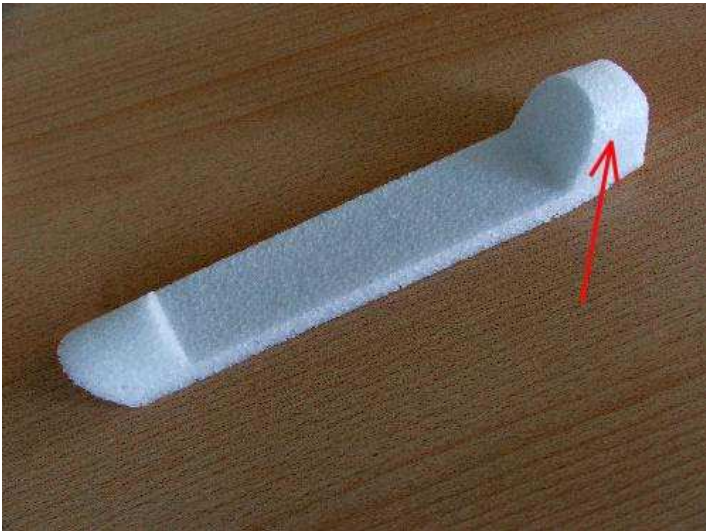

On the bottom part of the cabin paste rear part.

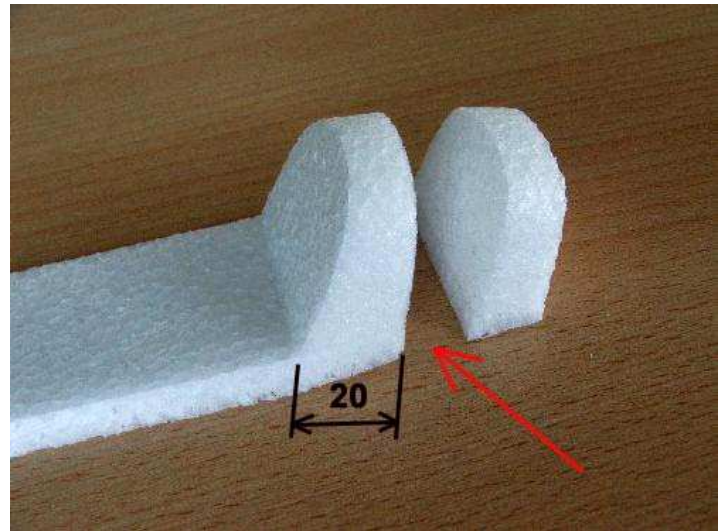

Cut with sharp knife in rear part lower part of the cab

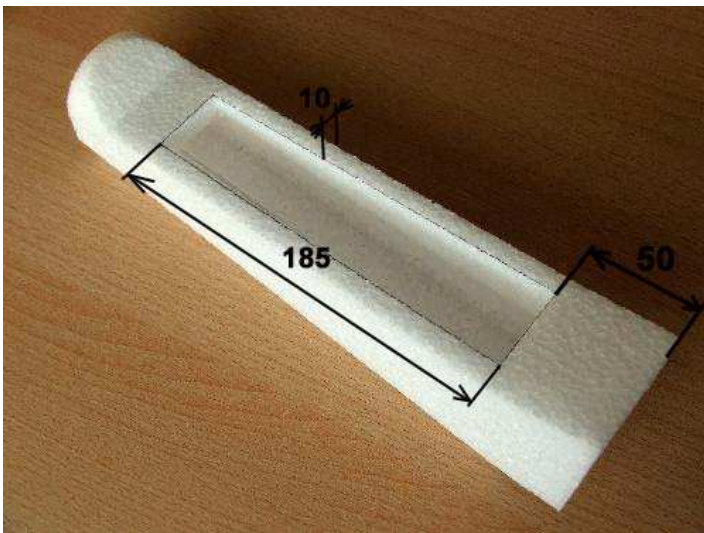

By drawing cut the opening for electronics.



In the bottom glue carbon reinforcement strip

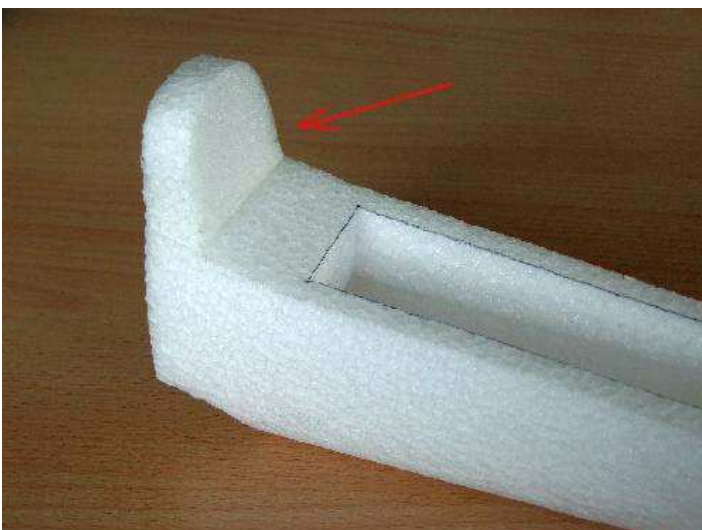

Glue an isolated part of the cab.

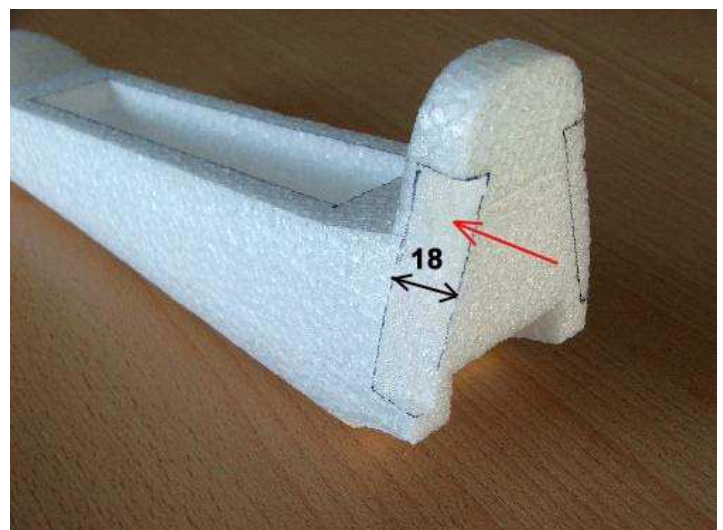

Cut crossways off part designated for the air intake



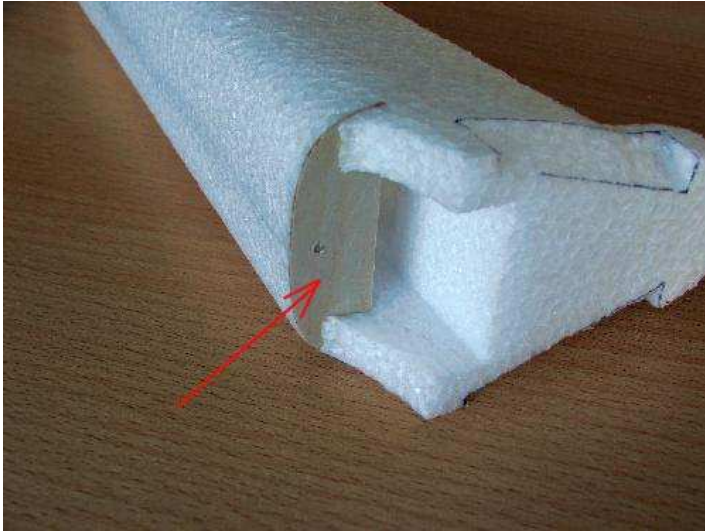

Stick plywood counter

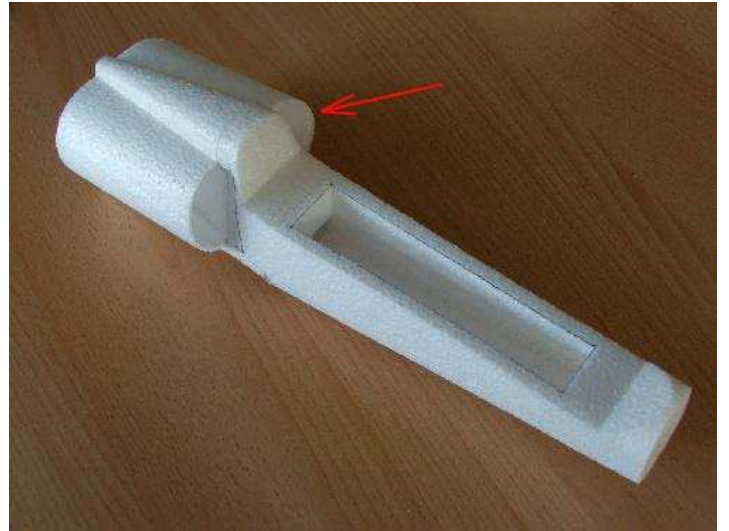

Paste two fuselage parts.



In the bottom section cut off rift for wires.



Glue another part of the fuselage.



Prepare opening for rod elevator.



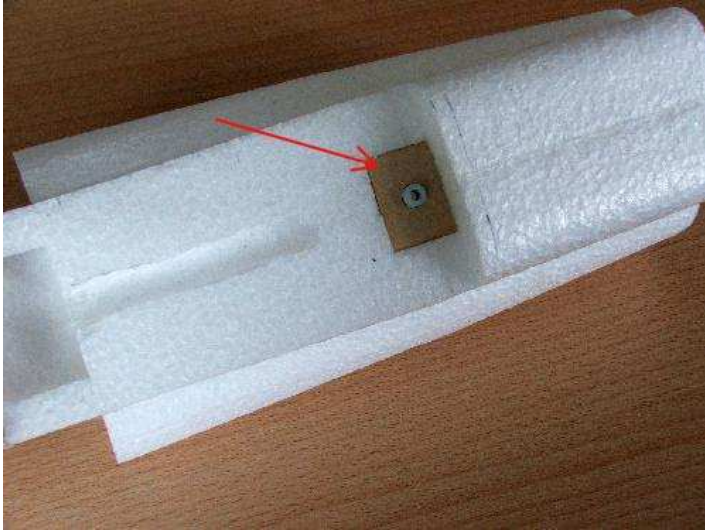

Hollow out space for the plate with a nut and stick up



Stick the front part of the fuselage.

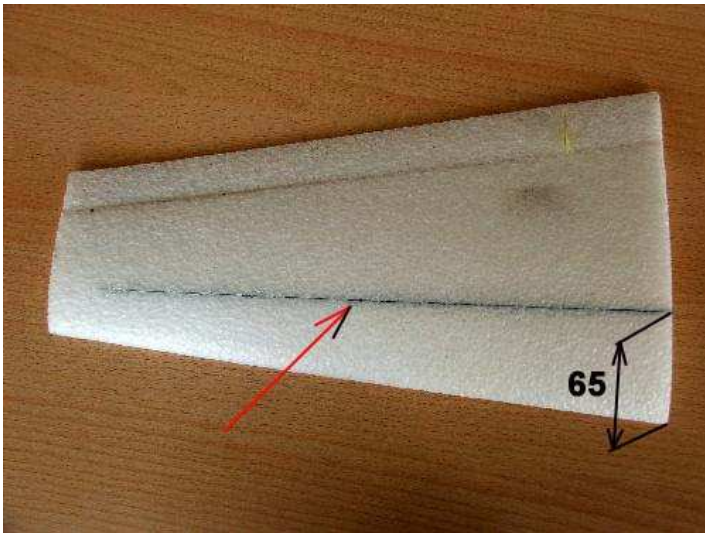

By sharp knife slice into rift, insert the plastic strip and glue with rare CyA glue.

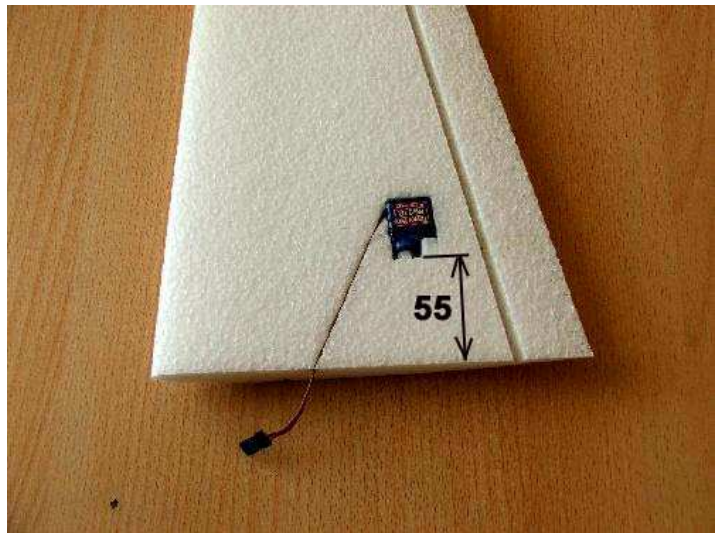

Make opening for the aileron servo.

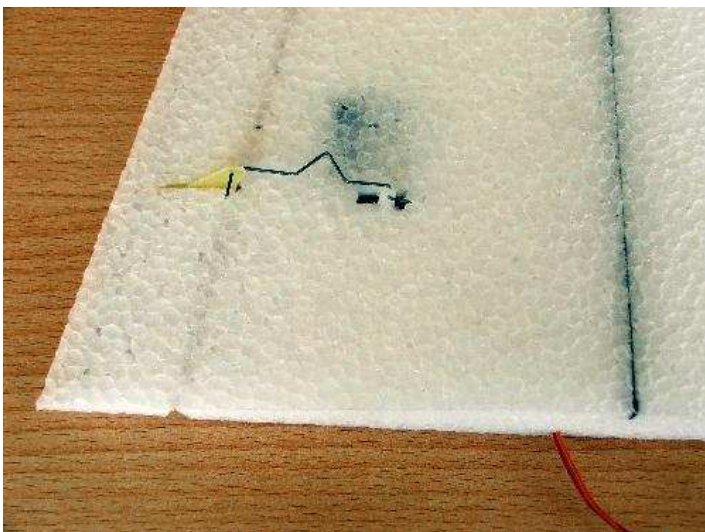

On top of the wing cut out rift for the servo lever and stick up control lever

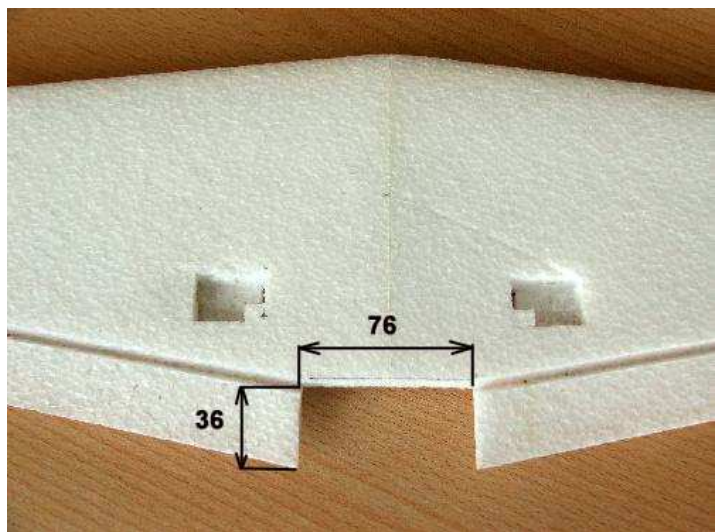

Both halves of the wings stick together and cut off the middle of the wings.



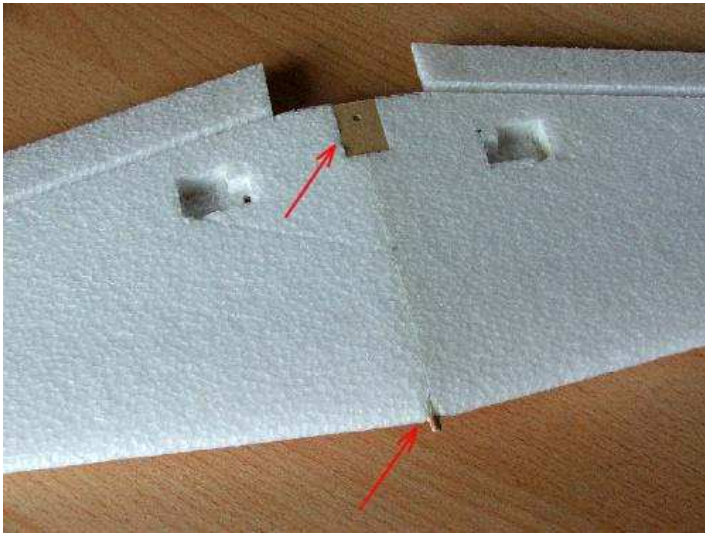

Stick the plywood plate and pin for attaching the wing



At the end of the wings attach "additional tanks"

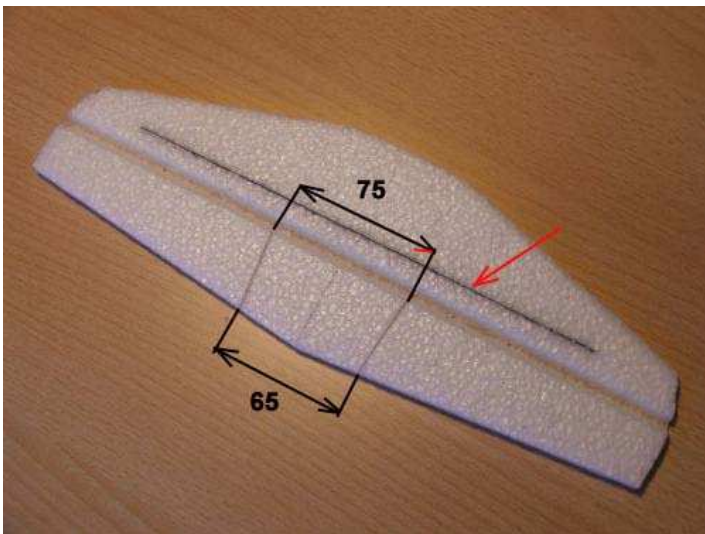

Cut the moving parts of elevator.  
Cut a rift and by rare CyA glue stick up the carbon strip.

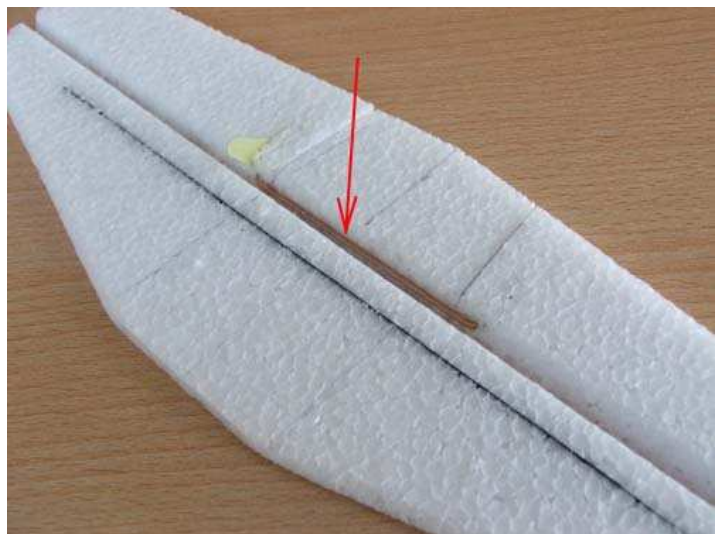

Moving parts of the elevator put together with a wire bent into "U"



Paste together paper tube



Paper tube insert and stick up to the rear of the fuselage



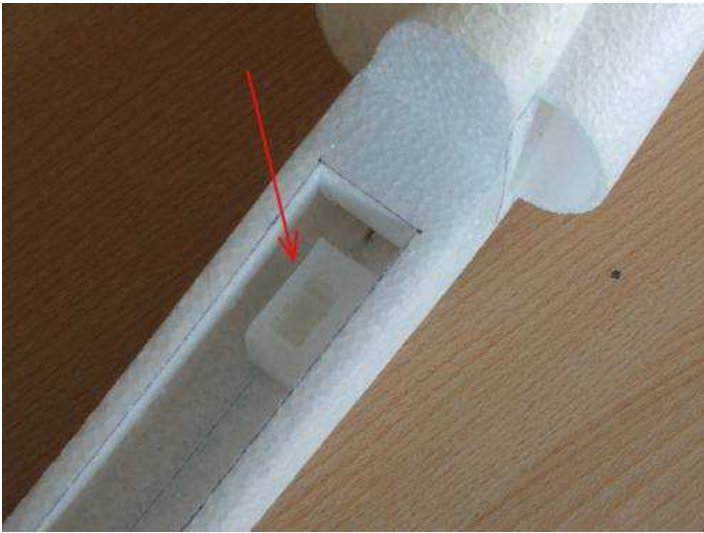

Ze zbytku EPP zhotovit lože pro servo výškovky.



Install rod of elevator.



On the removable part of the cab stick EPP plate.

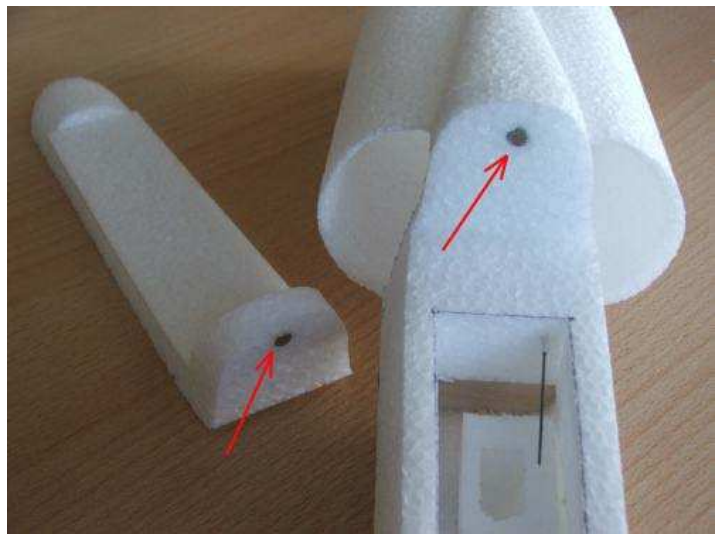

By CyA glue magnets for attach the cabin.

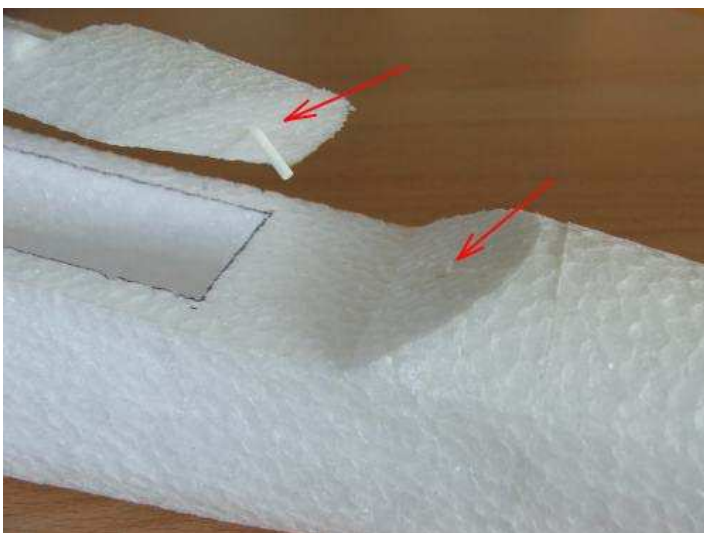

In front of the cabin glue pin and pipe for mounting the cab.



Prepare an extension cable for motor



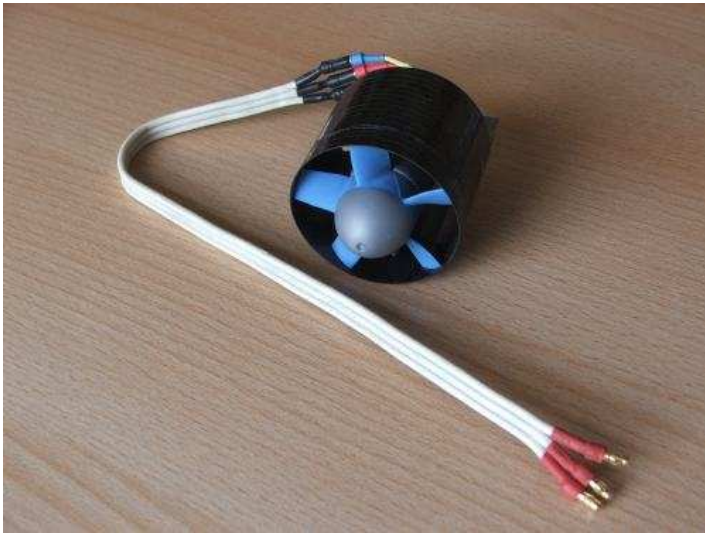

According to the manufacturer advice compile blower.



Blower together with the engine installed in the central part of the fuselage.



At the rear of the fuselage stick rudder and elevator.



The rear part of the fuselage stick after the test the drive and determinativ centre of gravity.



After the painted model glue cabin frame from paper.





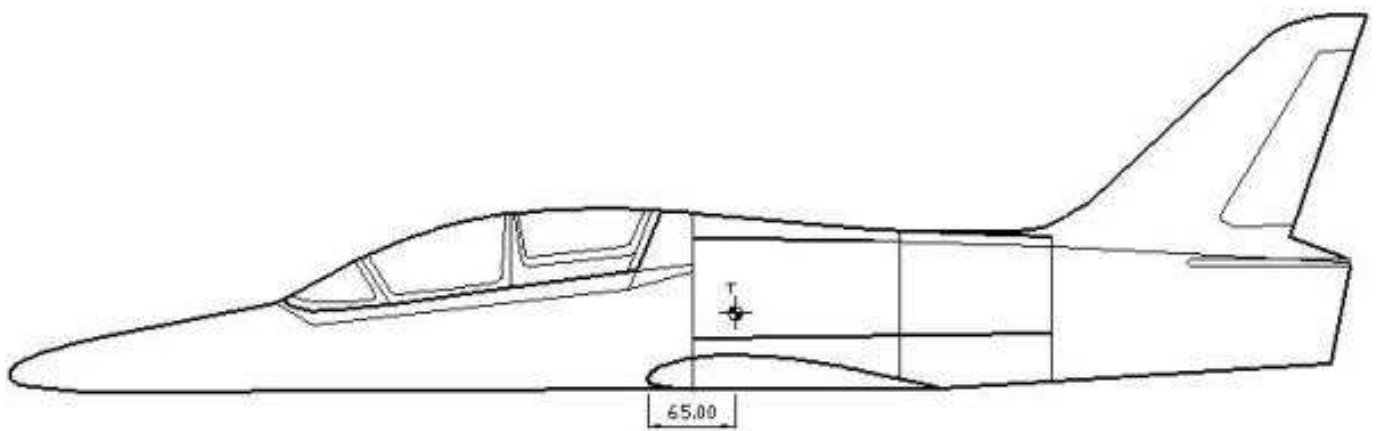
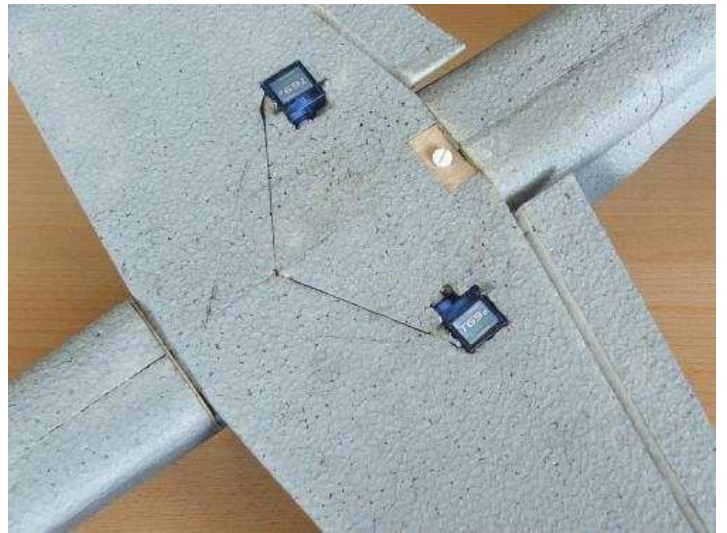

Accumulators and electronic equipment to deploy in such way that the center of gravity will be 65 mm from the leading edge. Measured at the point of contact with the wing with fuselage.





Paint the model by waterborn acrylate paints. Apply the color by the roller, or by brush. Use brush with stronger bristles, to get the paint into the pores of materials. Alternatively, the color can be spray painted with spray gun.

Before the first flying, check the position of the centre gravity, which adjust by shifting accumulator.

Set rudder deflection about 20- 30° at the beginning and 15-25° at the elevator.

It is recommended to make first test flights during windless weather.

We start the model with the engine at full, throw slightly up. For the first flights should be asked to throw the model helper.

Always fly in such a way to avoid injury to yourself as well as to your surroundings.

I wish you many happy hours during flying.

Libor Mašík  
Kobeřice  
Czech Republic

[www.lm-model.cz](http://www.lm-model.cz)